

**Inlet valve | Vorlauf-Ventil | kraan
regulační ventil | вентиль**

EN 12165-CW617N, brass | messing | messing | mosaz | латунь
max. 10bar | 100°C

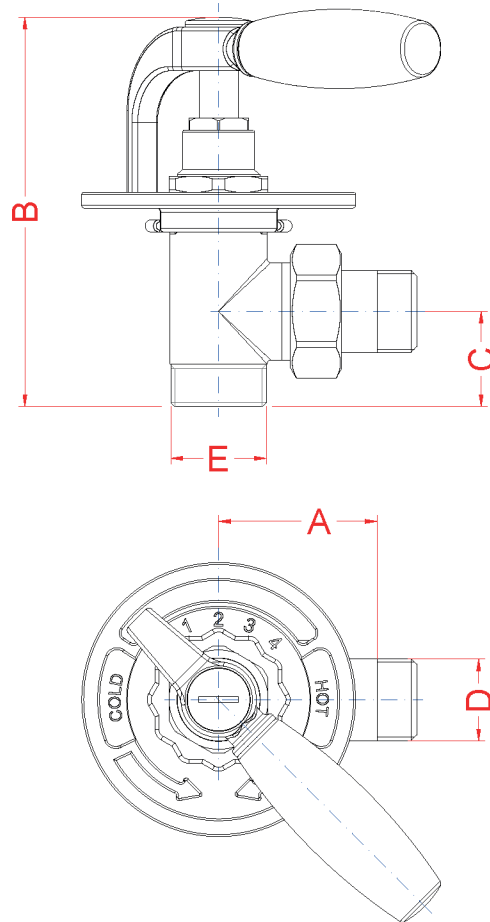

D	A	B	C	E
1/2"	40	98	24	24-19

all dimesions in mm

**Inlet valve | Vorlauf-Ventil | kraan
regulační ventil | ВЕНТИЛЬ**

K-V Diagramm, DN15 1/2"

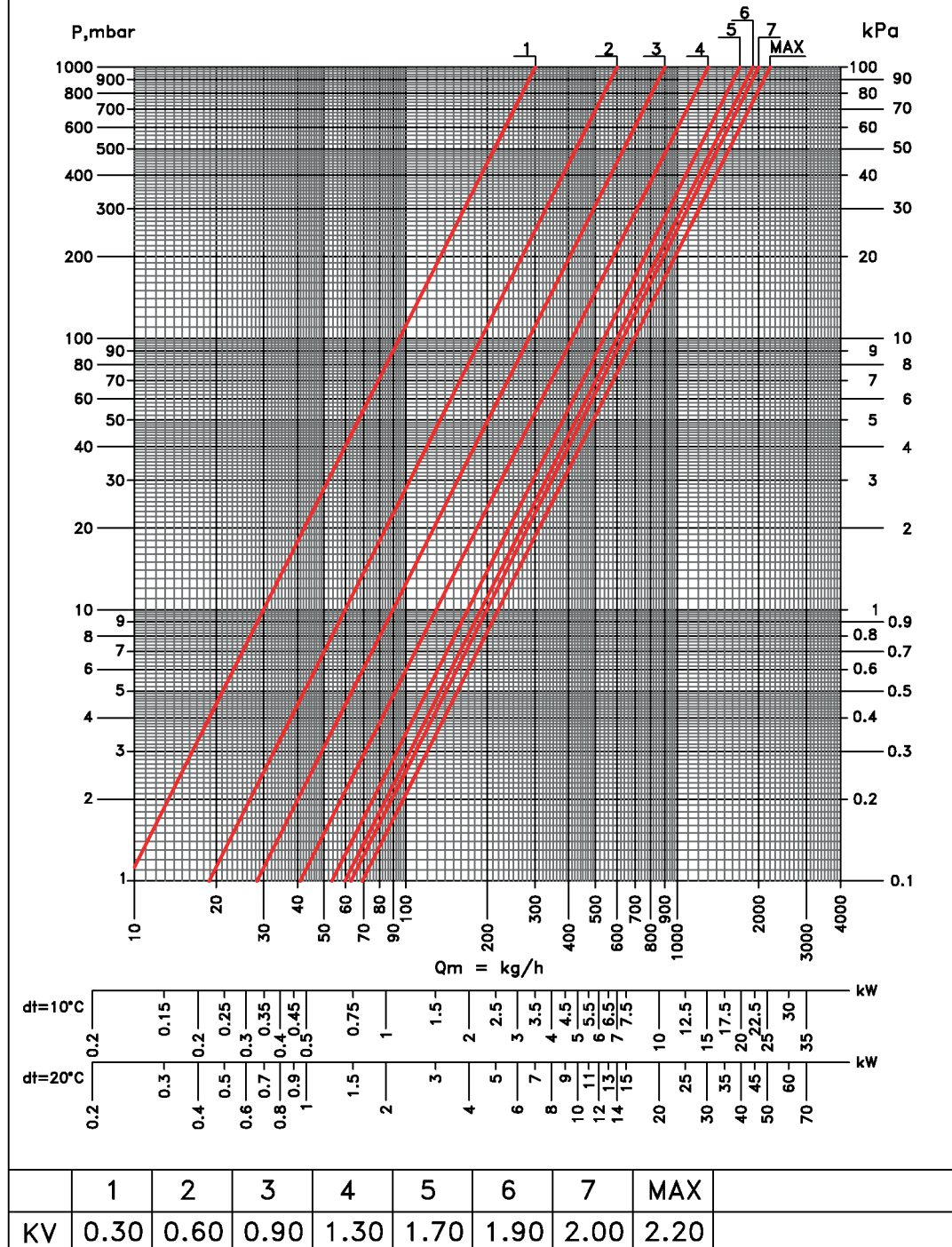

**Outlet valve | Rücklaufverschraubung | voetventiel
zpětné šroubení | вентил обратки**

EN 12165-CW617N, brass | messing | messing | mosaz | латунь
max. 10bar | 100°C

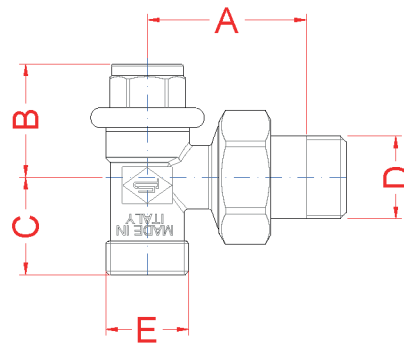

D	A	B	C	E
1/2"	40	28	24	24-19

all dimesions in mm

Outlet valve | Rücklaufverschraubung | voetventiel
zpětné šroubení | вентил обратки

K-V Diagramm, DN15 1/2"

